

AL-INVEST Verde 



DERECHOS DE PROPIEDAD INTELECTUAL



LATIN AMERICA

LA EUIPO Y EL DIBUJO O MODELO COMUNITARIO REGISTRADO

Carlos Mateo y Mar Portillo | ALICANTE | 12-03-2024



UN POCO DE HISTORIA

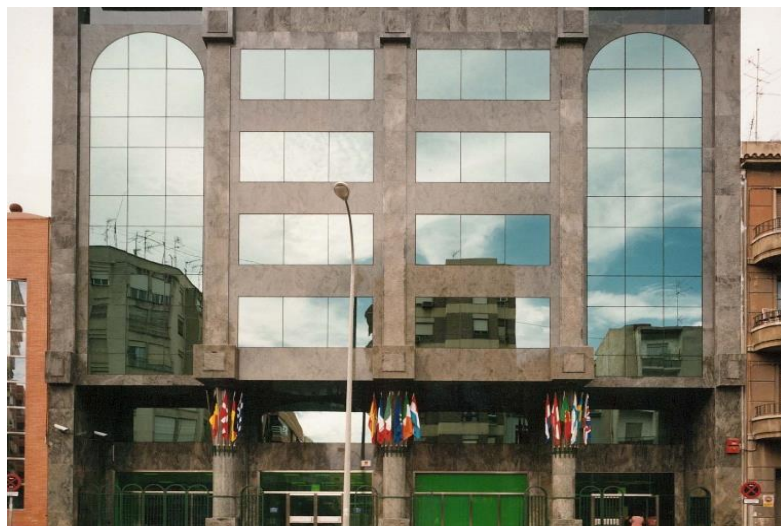

UN POCO DE HISTORIA



UN POCO DE HISTORIA

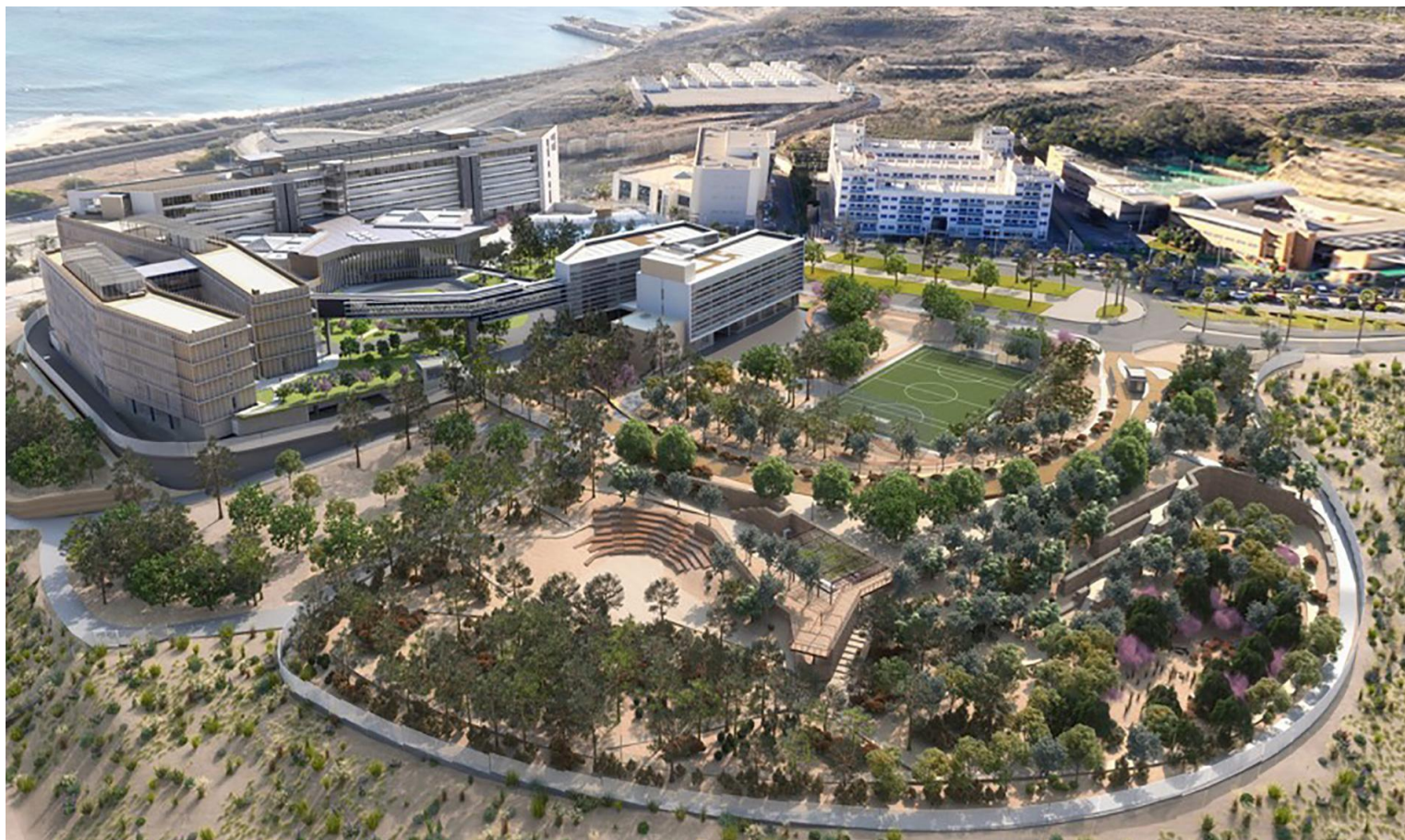

El primer diseño comunitario registrado

CASIO®

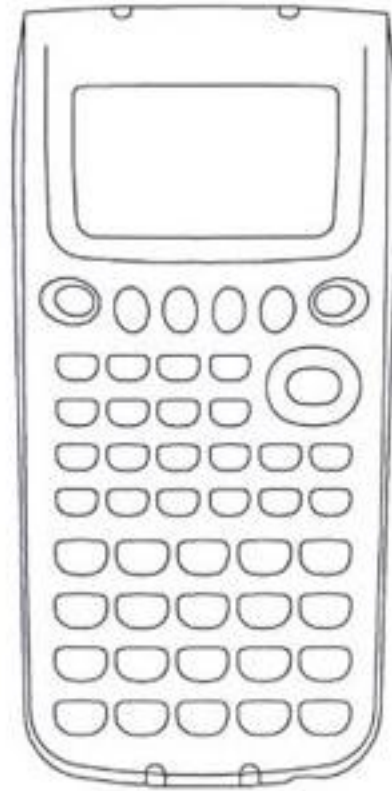

EL PRIMER DISEÑO COMUNITARIO REGISTRADO

RECIBIDO: 01/01/2003

DCR 000000013-0001

EVOLUCIÓN DE LA CALCULADORA

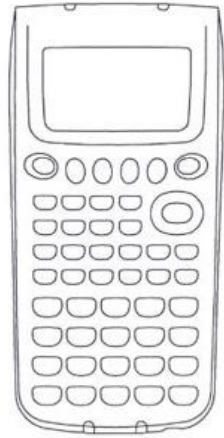

2003

DCR 000000013-0001



2014

DCR 002486779-0002



2015

DCR 002682989-0003



2016

DCR 003407816-0001

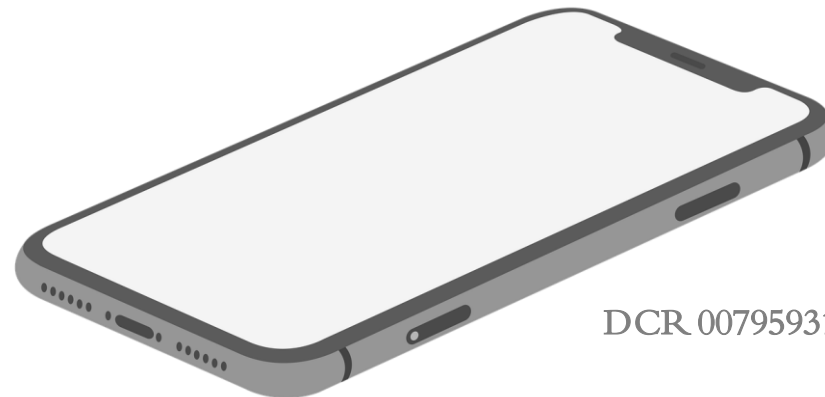

2020

DCR 007959317-0001

CASIO VUELVE A ESTAR DE MODA

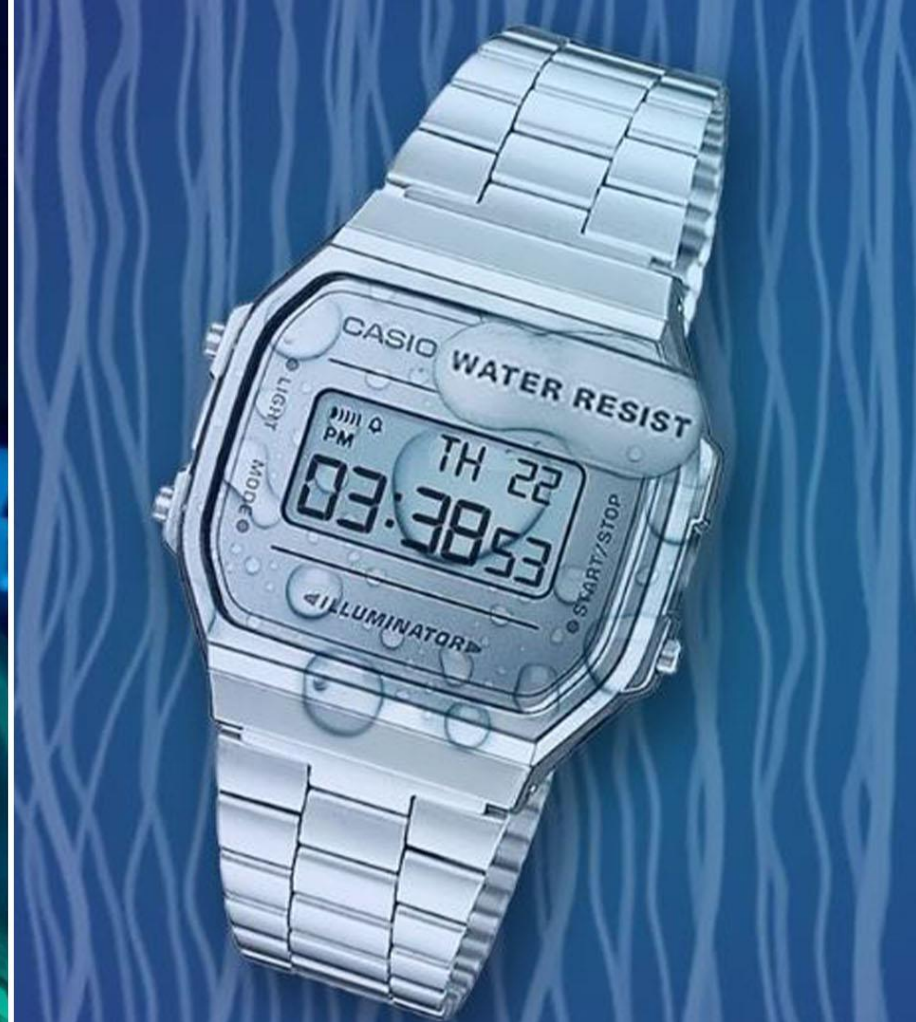
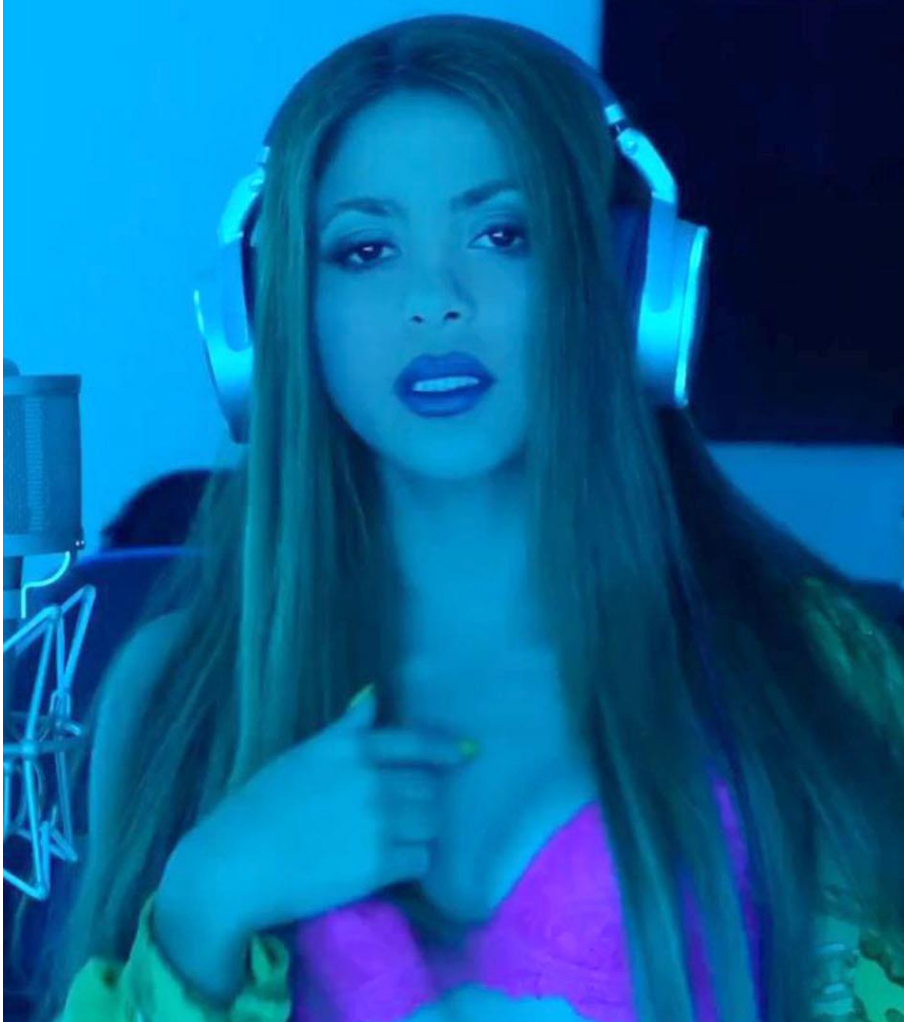

SEGUNDO DISEÑO



EL SEGUNDO DISEÑO
RECIBIDO: 01/01/2003

TITULAR:
MERCEDDES BENZ GROUP AG

DCR 000000021-0001

EVOLUCIÓN DEL DISEÑO AUTOMÓVILES



DCR 006271979-0001

RECIBIDO:
01/03/2019

TITULAR:
AUDI AG

EVOLUCIÓN DEL DISEÑO AUTOMÓVILES



DCR 006489217-0001

RECIBIDO: 20/05/2019

TITULAR:
ATLAS TECHNOLOGIES HOLDING
B.V.

EVOLUCIÓN DEL DISEÑO AUTOMÓVILES

AeroMobil



DCR 008855621-0001

RECIBIDO: 08/02/2022

TITULAR: Atlas Technologies Holding
B.V.

SIR JAMES DYSON

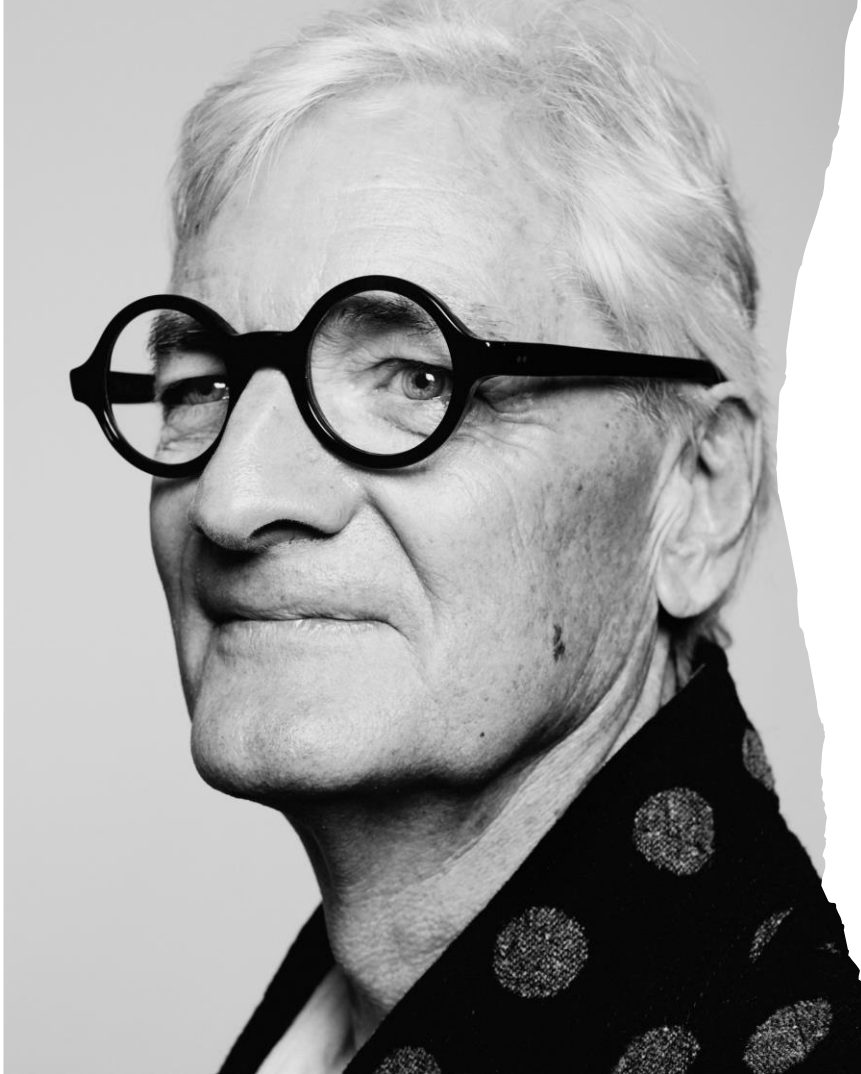

SIR JAMES DYSON

INVENTOR Y
DISEÑADOR
INDUSTRIAL
BRITÁNICO

NÚMERO DE DISEÑOS
REGISTRADOS:

46

DYSON



DCR 000469689-0001

RECIBIDO: 26/01/2006

DYSON



D C R 0 0 0 6 5 9 9 9 0 - 0 0 0 1

R E C I B I D O : 2 9 / 0 1 / 2 0 0 7

DYSON



DCR 001039911-0001
RECIBIDO: 17/11/2008

DCR 001057418-0001
RECIBIDO: 17/12/2008

DCR 001133292-0001
RECIBIDO: 01/05/2009

ZAHA HADID



DAME ZAHA HADID

ARQUITECTA,
ARTISTA Y
DISEÑADORA
BRITÁNICO-IRAQUÍ

NÚMERO DE DISEÑOS
REGISTRADOS:

17

ZAHA HADID

DCR 000366901-0001

RECIBIDO: 04/07/2005



ZAHA HADID



DCR 001120646-0014

RECIBIDO: 10/04/2009

ZAHA HADID



DCR 002258327-0001/0011

RECIBIDO: 19/06/2013

PHILIPPE STARCK



PHILIPPE STARCK
ARQUITECTO Y
DISEÑADOR
INDUSTRIAL
FRANCÉS

NÚMERO DE
DISEÑOS
REGISTRADOS: 563

PHILIPPE STARCK

DCR 000023692 (33 DISEÑOS)

RECIBIDO: 10/04/2003

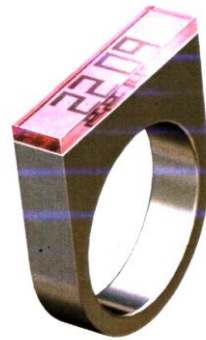
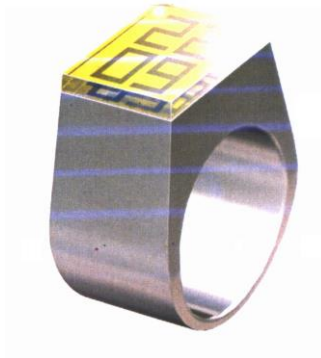

PHILIPPE STARCK



DCR 001124606 (1-4)

RECIBIDO: 21/04/2009

PHILIPPE STARCK

DCR 002123273-0001
Recibido: 23/10/2012



Venus, Súper Yate

PATRICIA URQUIOLA



PATRICIA URQUIOLA

ARQUITECTA,
DISEÑADORA Y
DIRECTORA DE
ARTE ESPAÑOLA

NÚMERO DE DISEÑOS
REGISTRADOS:

204

PATRICIA URQUIOLA



DCR 001206544-1/19

RECIBIDO: 08/04/2010

PATRICIA URQUIOLA



DCR 001880949-1/9

RECIBIDO: 21/06/2011

PATRICIA URQUIOLA

R C D 004426930-1/10 RECIBIDO: 31/10/2017



DEFINICIÓN DE DISEÑO

¿Qué es un Dibujo o Modelo Comunitario Registrado?

DEFINICIÓN DE DISEÑO

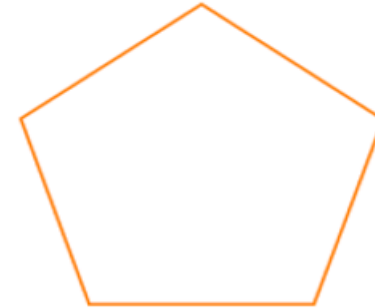
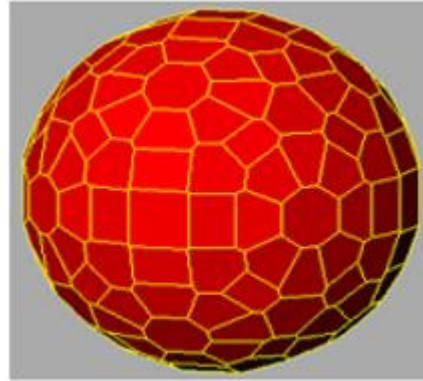
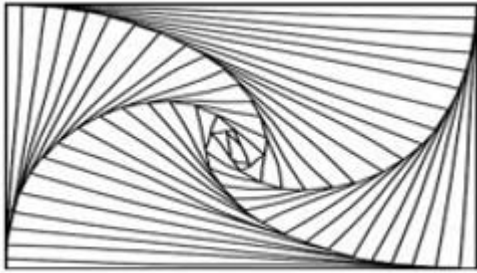

DEFINICIÓN DE DISEÑO



DCR 009150899-0021

DEFINICIÓN DE DISEÑO

NO CORRESPONDEN A LA DEFINICIÓN DE DIBUJO O MODELO

- Organismos vivos y productos naturales
- Ideas, métodos, procesos, funciones
- Meros elementos verbales sin contenido figurativo
- Colores *per se*
- Olores y fragancias
- Música y sonidos



DEFINICIÓN DE DISEÑO

CONTRA EL ORDEN PÚBLICO Y LAS BUENAS COSTUMBRES

- No son aceptables las imágenes o mensajes racistas, los símbolos nazis y las imágenes obscenas o inmorales.
- Las banderas y símbolos religiosos son aceptables siempre y cuando se apliquen de forma adecuada y decente.

DEFINICIÓN DE DISEÑO

CONTRA EL ORDEN PÚBLICO Y LAS BUENAS COSTUMBRES



DISEÑOS
ACEPTABLES

OTROS DISEÑOS

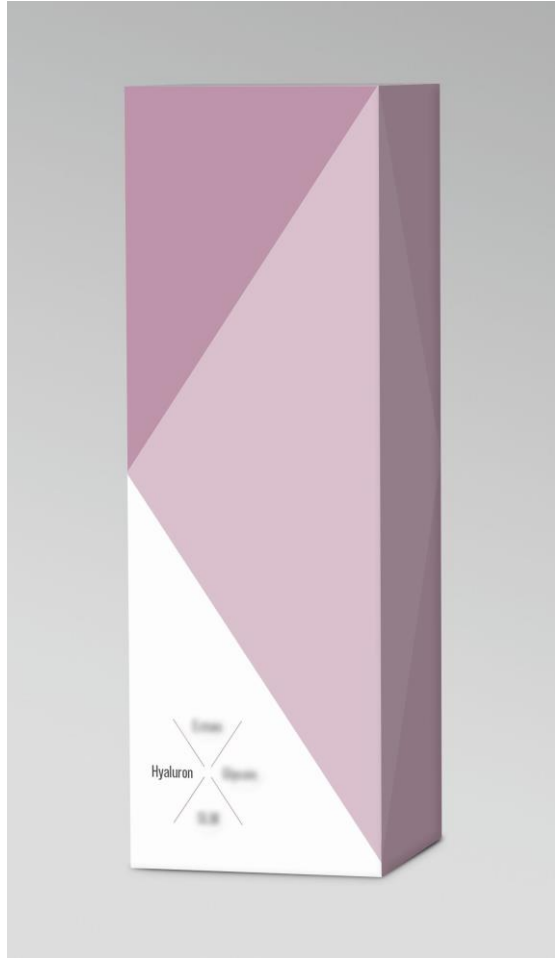

OTROS DISEÑOS



DCR 2213793-0001

OTROS DISEÑOS

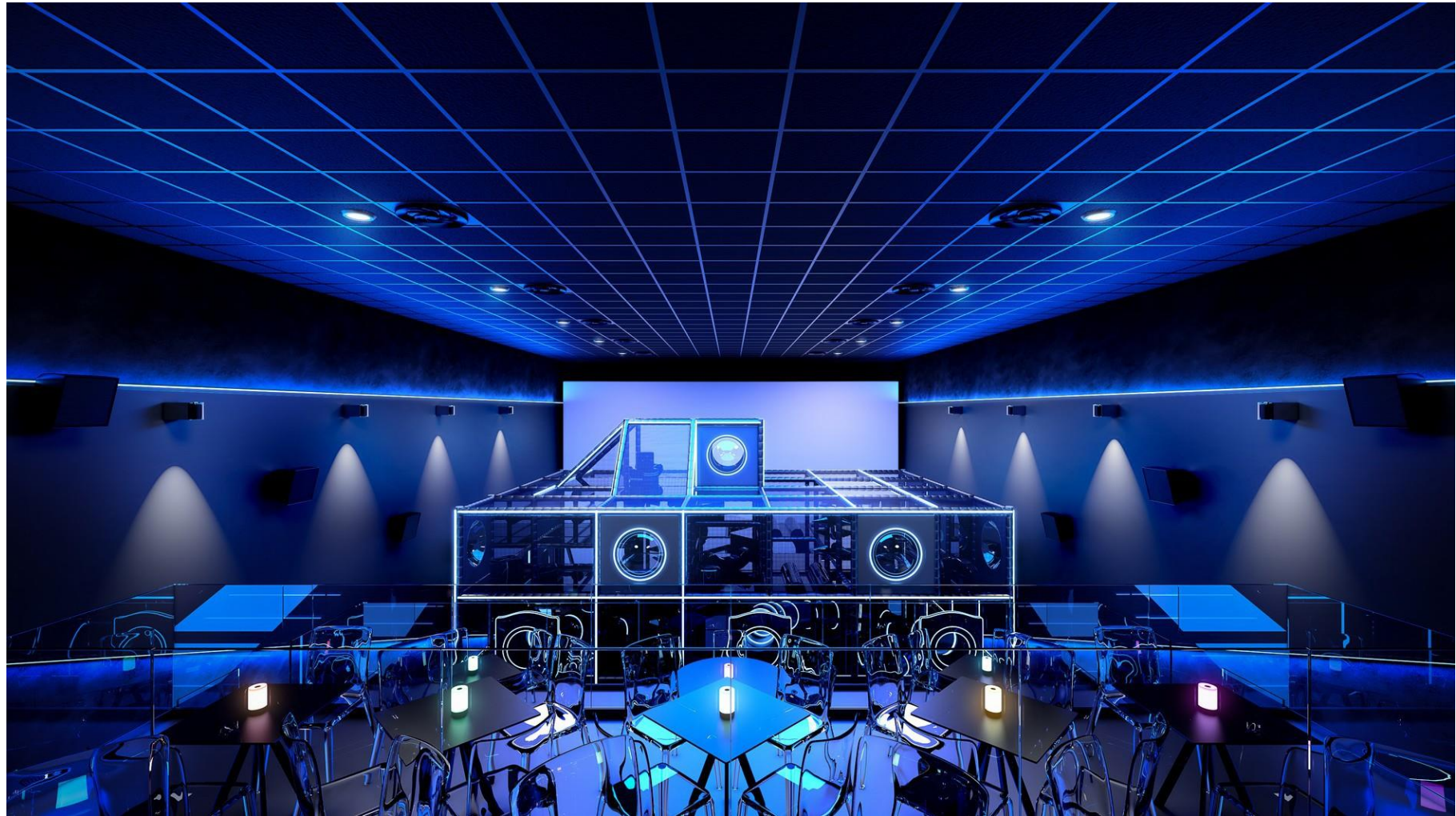

DCR
007832654-003

OTROS DISEÑOS



DCR 15043269

OTROS DISEÑOS



DCR 84223-0002

OTROS DISEÑOS

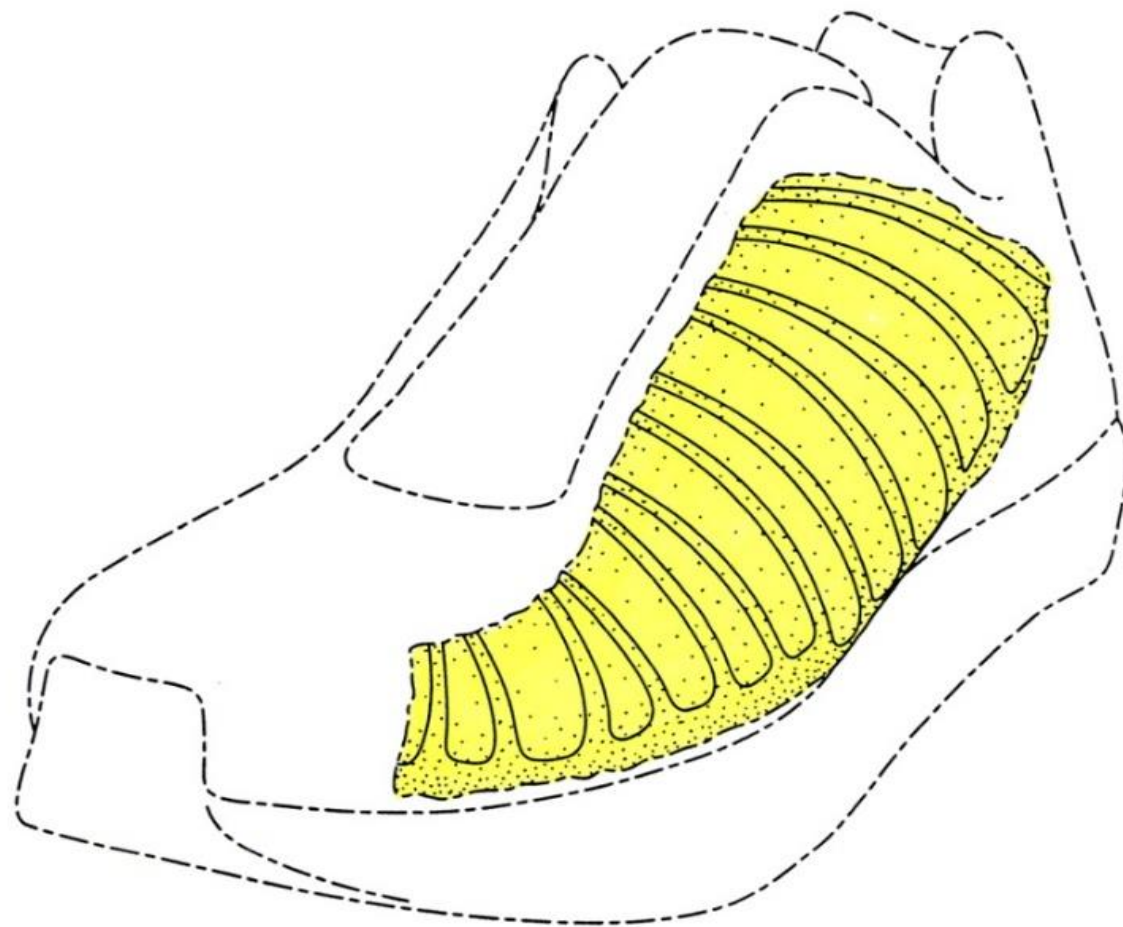

RCD 000016290

OTROS DISEÑOS

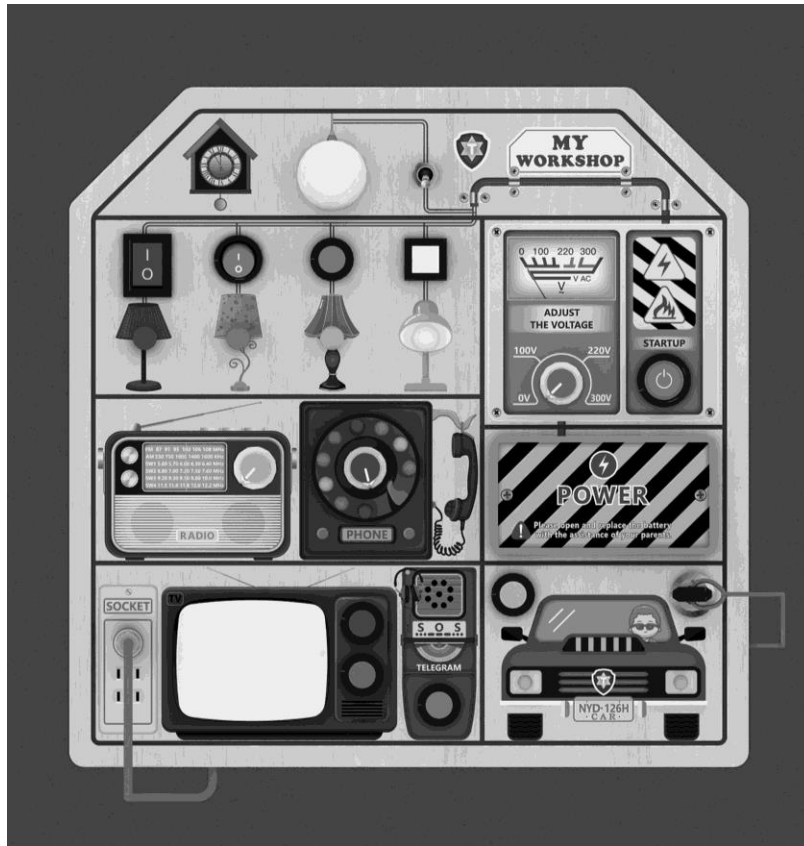

DCR 015045730



DCR 015043708

OTROS DISEÑOS



DCR 1462642-0002



DCR 006469698-0006



DCR 006469698-0006

OTROS DISEÑOS



DCR 004527950-0001, 013783618



OTROS DISEÑOS

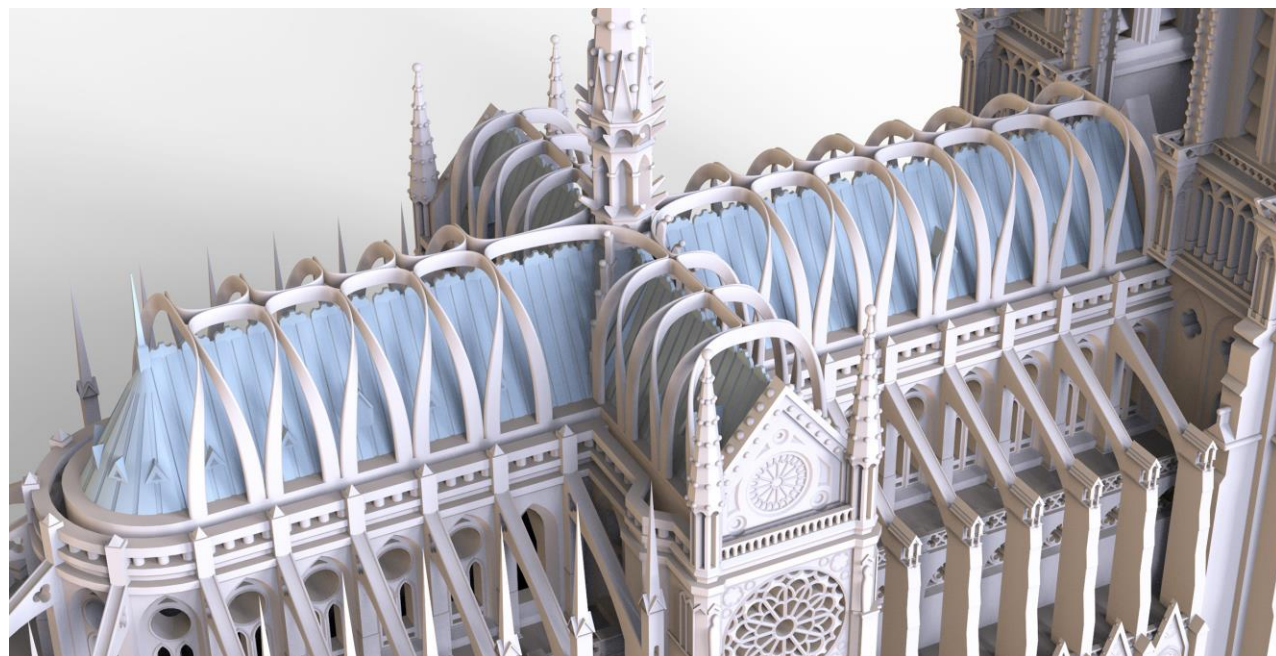

DCR 007364617-0001

OTROS DISEÑOS



DCR 005817533-0003, 018599959

Proceso de registro



Proceso de examen

Elementos obligatorios de una solicitud

- Tasas
- Identificación del solicitante
- Indicación de producto
- Representación del diseño

Proceso de examen

Elementos obligatorios de una solicitud

- **Tasas**
- Identificación del solicitante
- Indicación de producto
- Representación del diseño

Proceso de examen

Registro y publicación

350 €

Del diseños 2 al 10:175 EUR

Del diseño 11 en adelante:80 EUR

Aplazamiento de la publicación

40 €

Del diseño 2 al 10:20 EUR

Del diseño 11 en adelante:..80 EUR

Proceso de examen

Elementos obligatorios de una solicitud

- Tasas
- **Identificación del solicitante**
- Indicación de producto
- Representación del diseño

Proceso de examen

Cualquier persona física o jurídica puede ser titular de un Dibujo o Modelo Comunitario Registrado

Proceso de examen

Solicitante fuera del EEE

John Doe

Camino Street 10, 1B

098867 Ciudad

País fuera del EEE

Representante (necesario)

Jane Doe

Urbanstrasse 10, 1B

098867 Ciudad

País del EEE

Proceso de examen

Personas físicas

Nombre: Manolo Jiménez

Dirección:

Urbanstrasse 10, 1B

098867 Berlín

Alemania

Nacionalidad: Española

Proceso de examen

Personas jurídicas

Nombre: Manolo

Forma Jurídica:

Sociedad Limitada

Dirección:

Calle del Camino 10, 1B

02005 Ciudad

España

Proceso de examen

Elementos obligatorios de una solicitud

- Tasas
- Identificación del solicitante
- **Indicación de producto**
- Representación del diseño

INDICACIÓN DE PRODUCTO

Automóviles, Locarno Class 12-08



INDICACIÓN DE PRODUCTO

SOLICITUDES INDIVIDUALES:

Varias indicaciones de producto distintas y varias clases de Locarno distintas

SOLICITUDES MÚLTIPLES:

Indicaciones de producto distintas **pero sólo una clase de Locarno** (que se puede combinar con la clase 32-00)

INDICACIÓN DE PRODUCTO

Diseño 1:
Tazas – Clase de Locarno 07



Diseño 2:
Marcos - Clase de Locarno 06



INDICACIÓN DE PRODUCTO

Diseño 1:

Tazas – Clase de Locarno 07



Diseño 2:

Ornamentación – Clase de Locarno 32-00

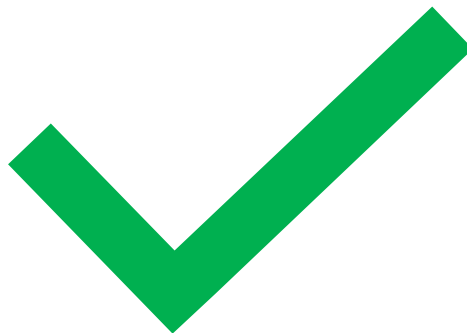

INDICACIÓN DE PRODUCTO

Diseño 1:

Tazas – Clase de Locarno 07



Diseño 2:

Ornamentación – Clase de Locarno 32-00

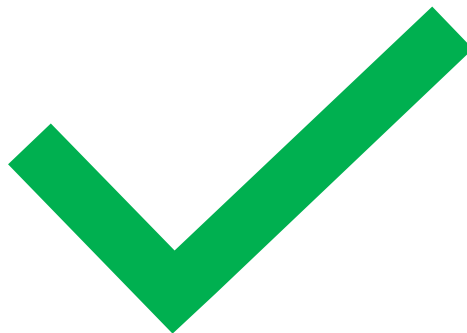

INDICACIÓN DE PRODUCTO

Diseño 1:

Tazas – Clase de Locarno **07**



Diseño 2:

Ornamentación – Clase de Locarno **32-00**

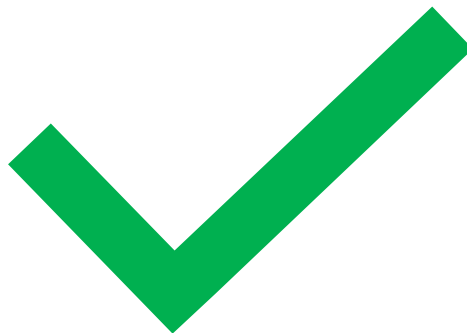

**Coffee
break!**

Proceso de examen

Elementos obligatorios de una solicitud

- Tasas
- Identificación del solicitante
- Indicación de producto
- **Representación del diseño**

Proceso de examen

CONSISTENTE



Proceso de examen

CONSISTENTE

CLARA

Proceso de examen

CONSISTENTE

CLARA

ENTORNO VACÍO

Proceso de examen



Proceso de examen

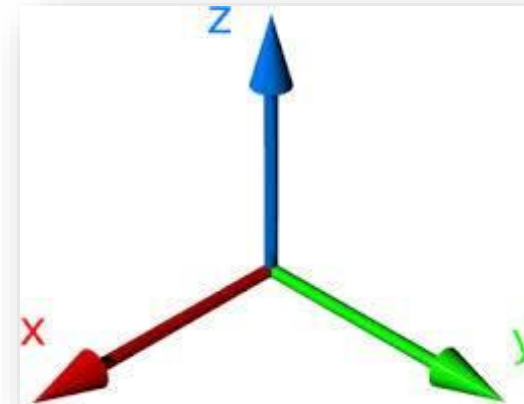
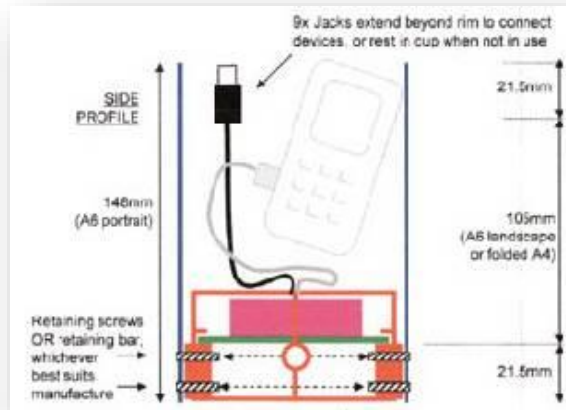

Proceso de examen



Proceso de examen

¿Por qué es tan importante la representación del diseño?

1. La indicación de producto **no es vinculante** ✘
2. La descripción **no es vinculante** ✘
3. La representación del diseño **sí es vinculante** ✔

Proceso de examen



Proceso de examen



Proceso de examen



Indicación de producto:
Sillas con reposapiés

Descripción:
Sólo se busca protección para la silla con reposapiés. El resto de elementos de la foto son puramente decorativos.

Proceso de examen

Descripción

No se busca protección para los colores.



Proceso de examen

CONSISTENTE



Proceso de examen

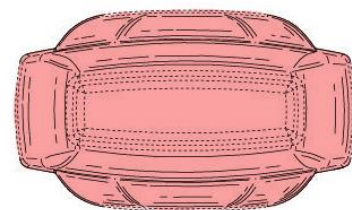
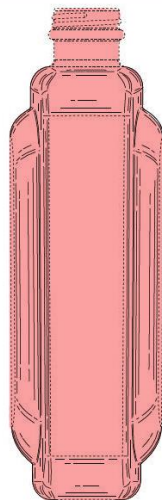
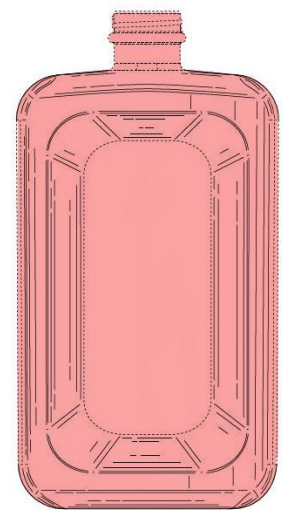
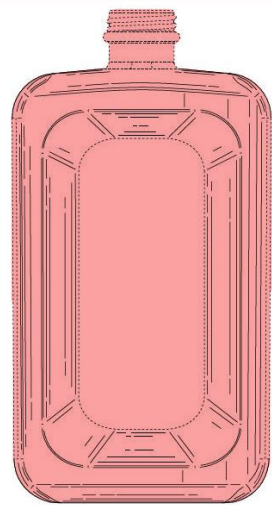
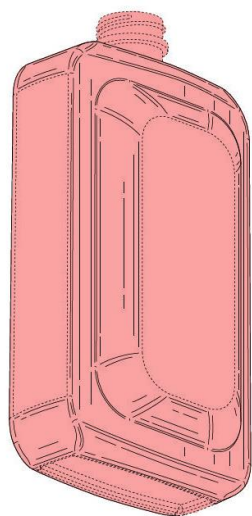
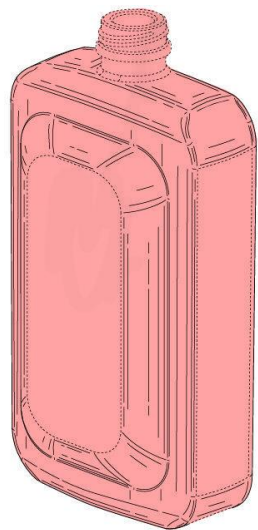

Proceso de examen

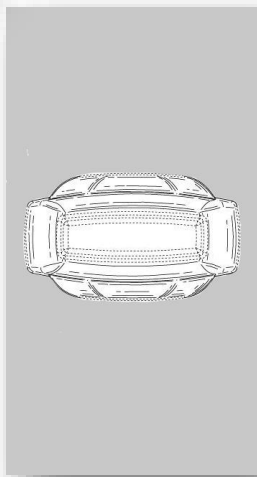
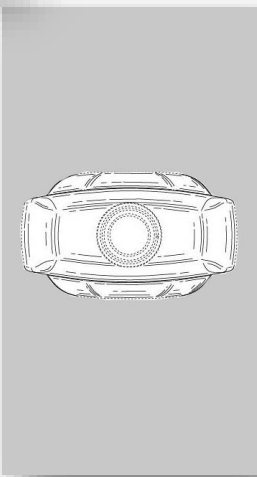
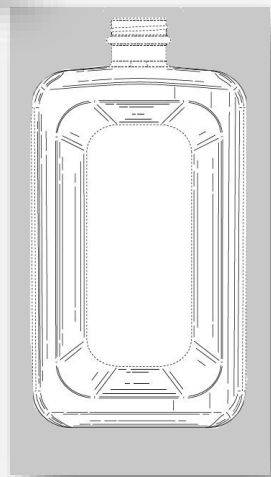
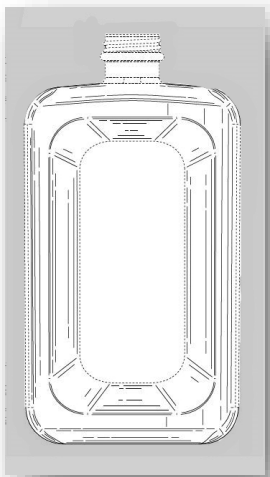
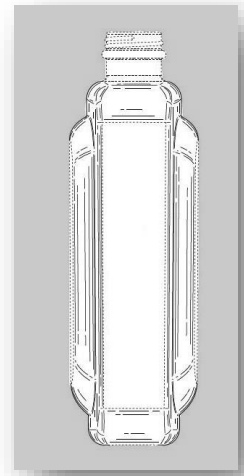
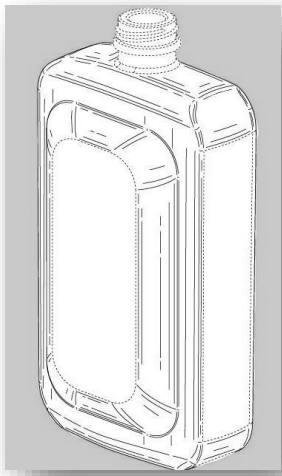
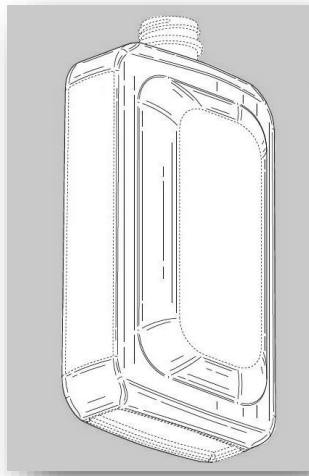

Proceso de examen

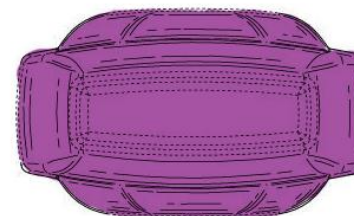
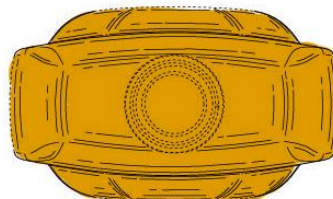
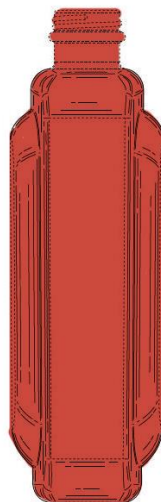
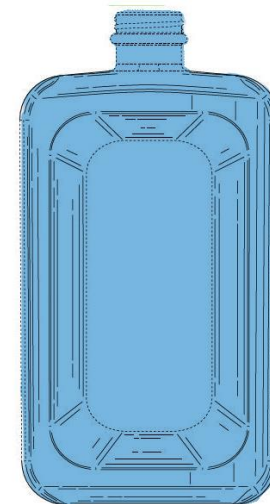
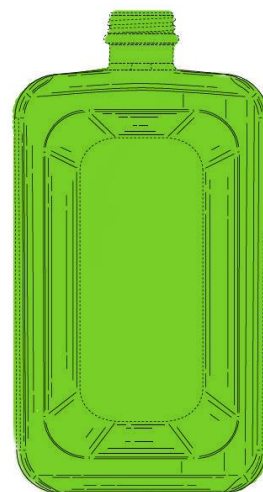
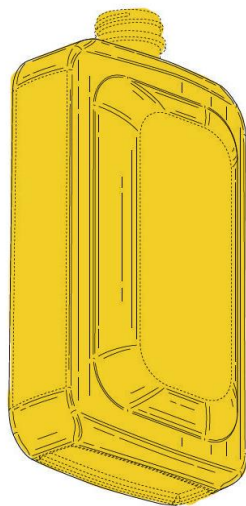
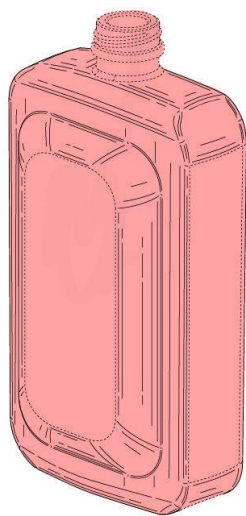

Proceso de examen

DISEÑO 1

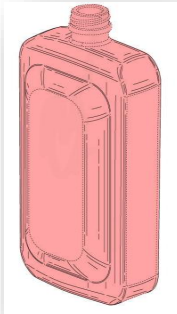

DISEÑO 2

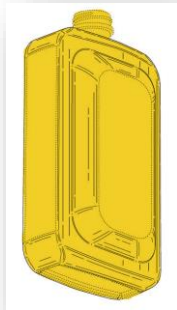

DISEÑO 3

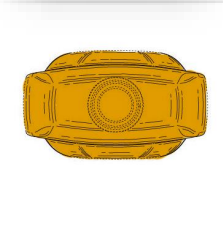

DISEÑO 4



DISEÑO 5

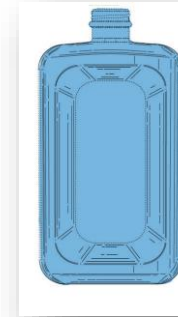

DISEÑO 6



DISEÑO 7



Proceso de examen



Proceso de examen



Proceso de examen



Proceso de examen

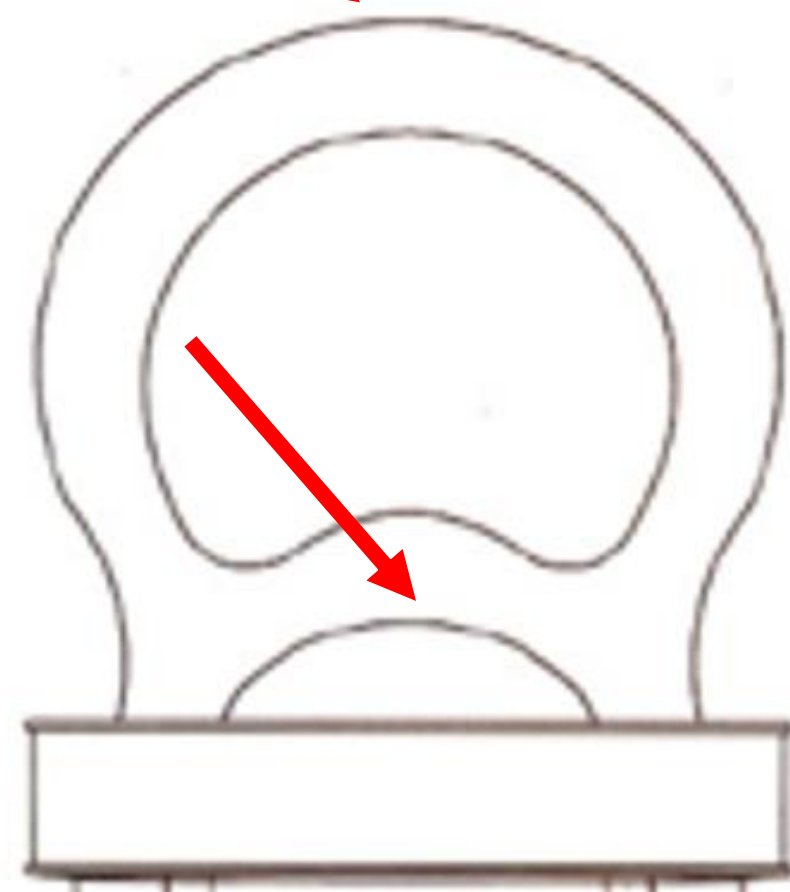
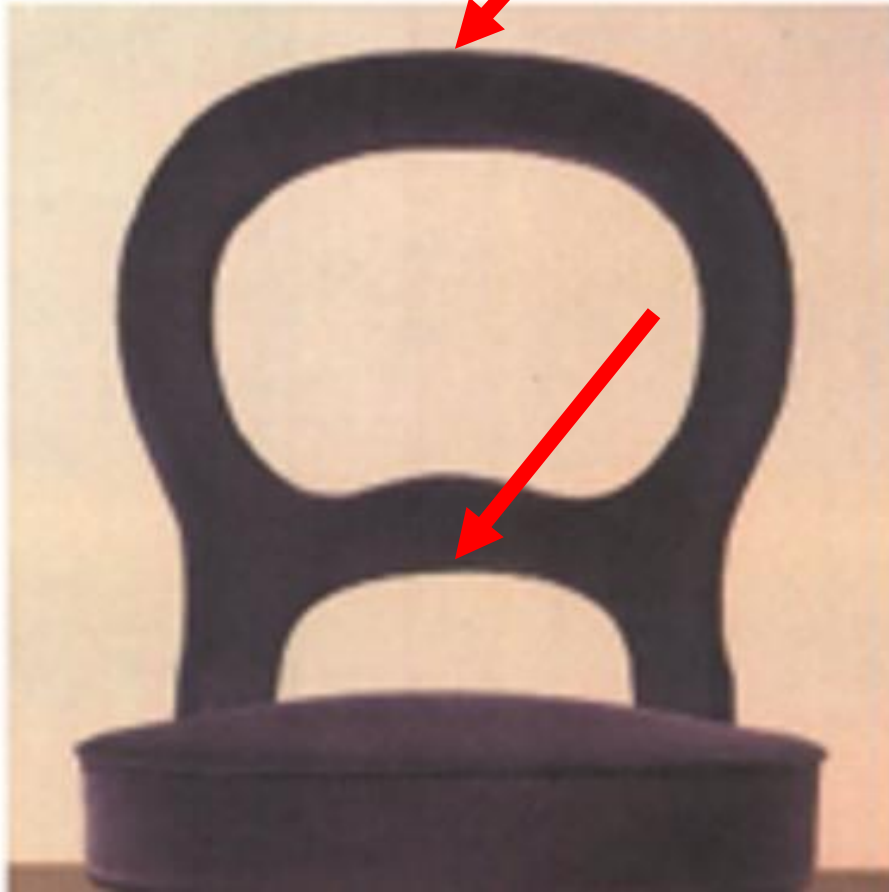

Proceso de examen



Proceso de examen



Proceso de examen

CONSISTENTE

CLARA

Proceso de examen

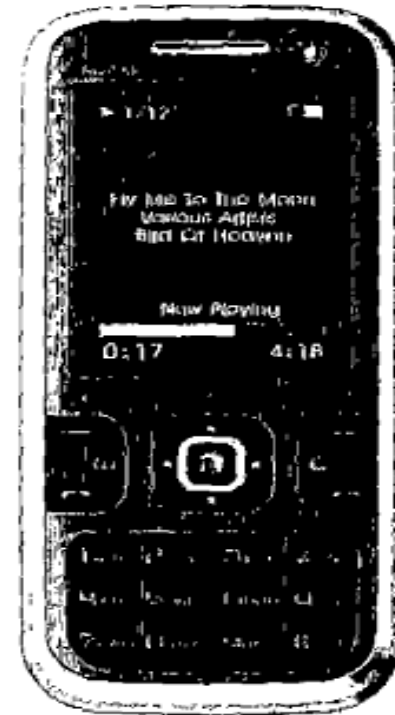
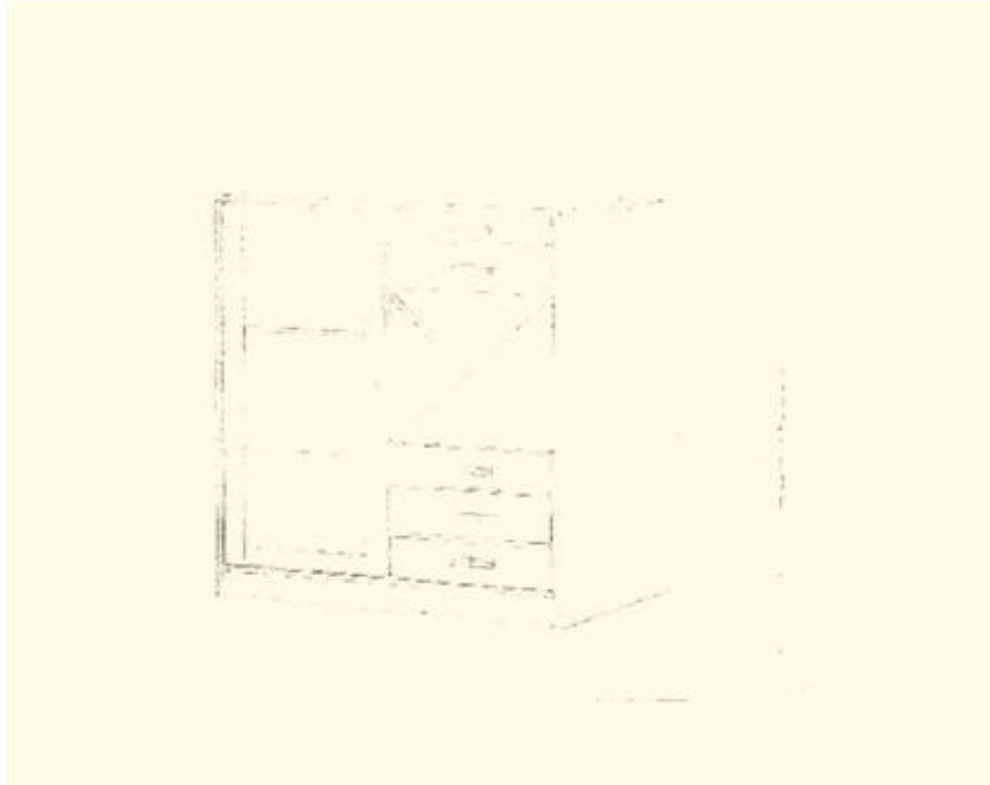

Proceso de examen



Proceso de examen

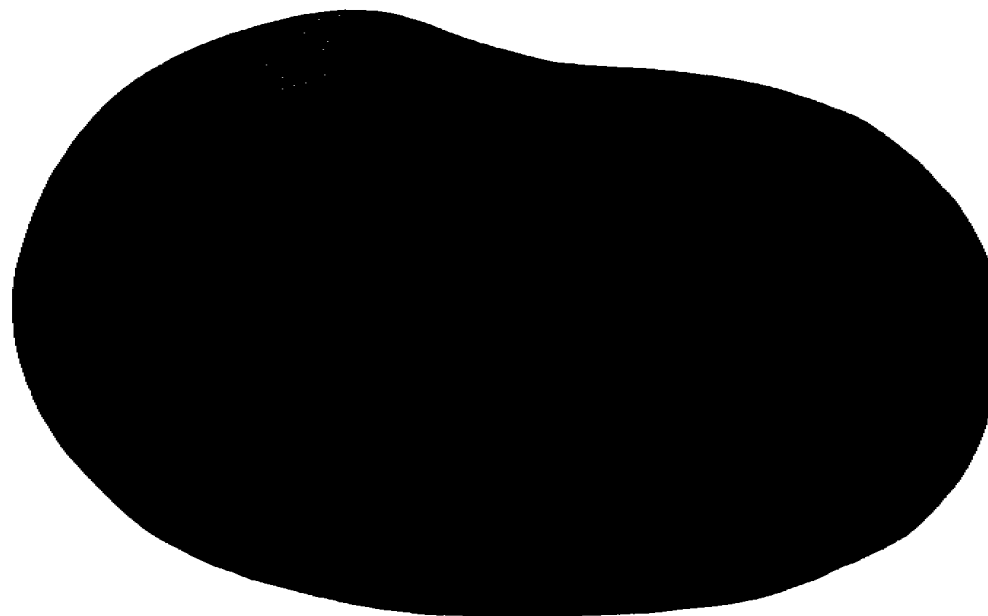
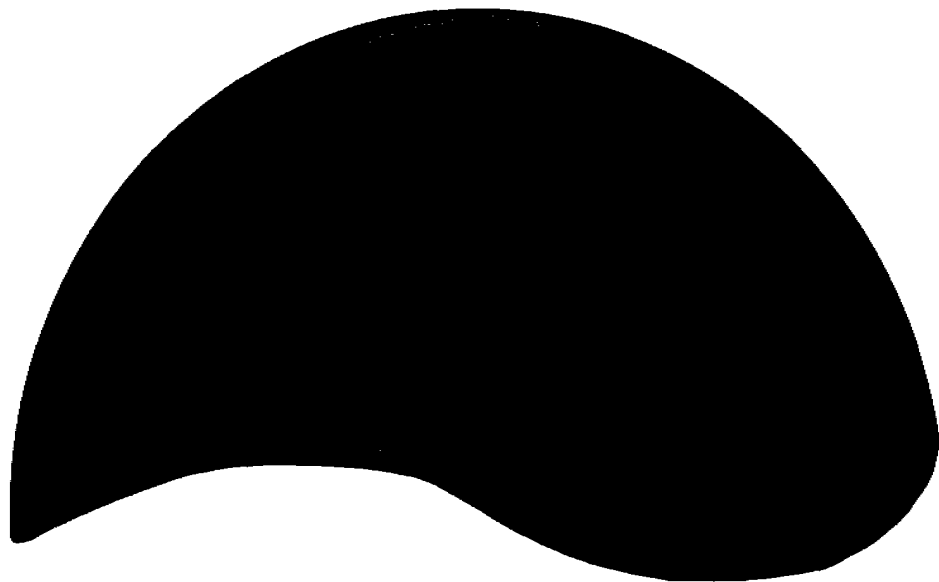

Proceso de examen



Proceso de examen

CONSISTENTE

CLARA

ENTORNO VACÍO

Proceso de examen

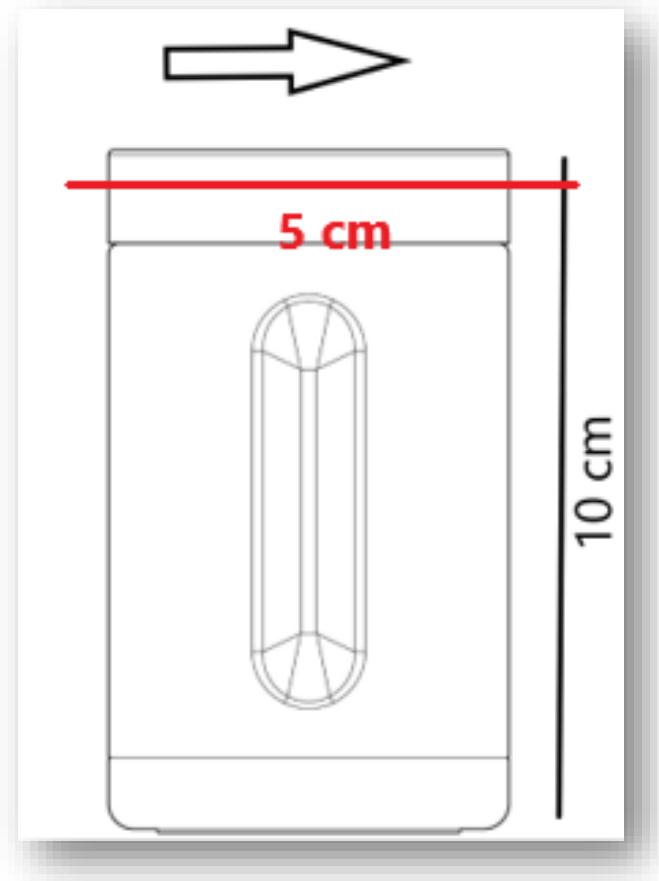

Proceso de examen

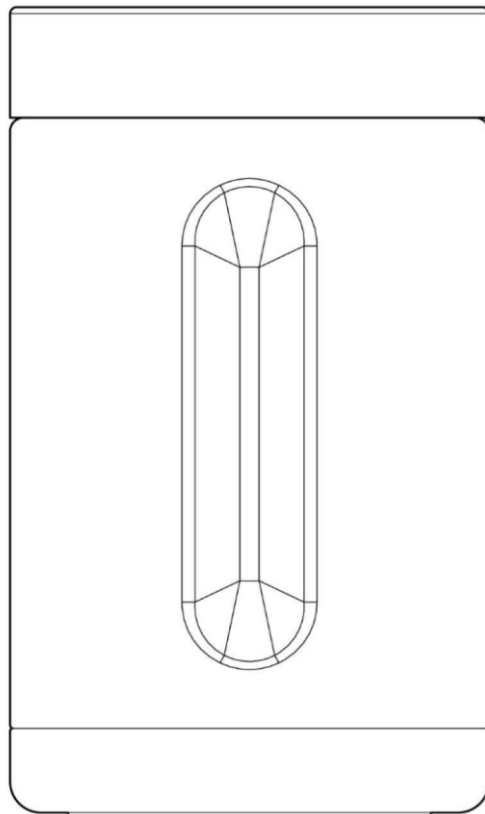

Proceso de examen

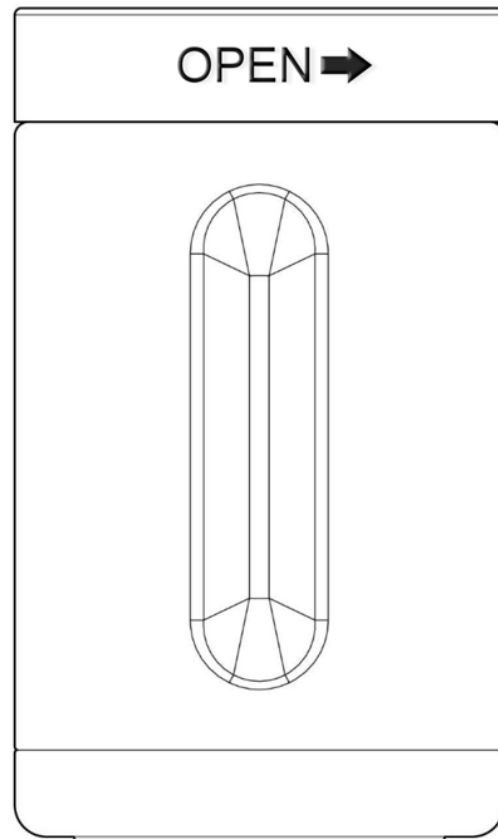

Proceso de examen



Proceso de examen



Proceso de examen



Proceso de examen

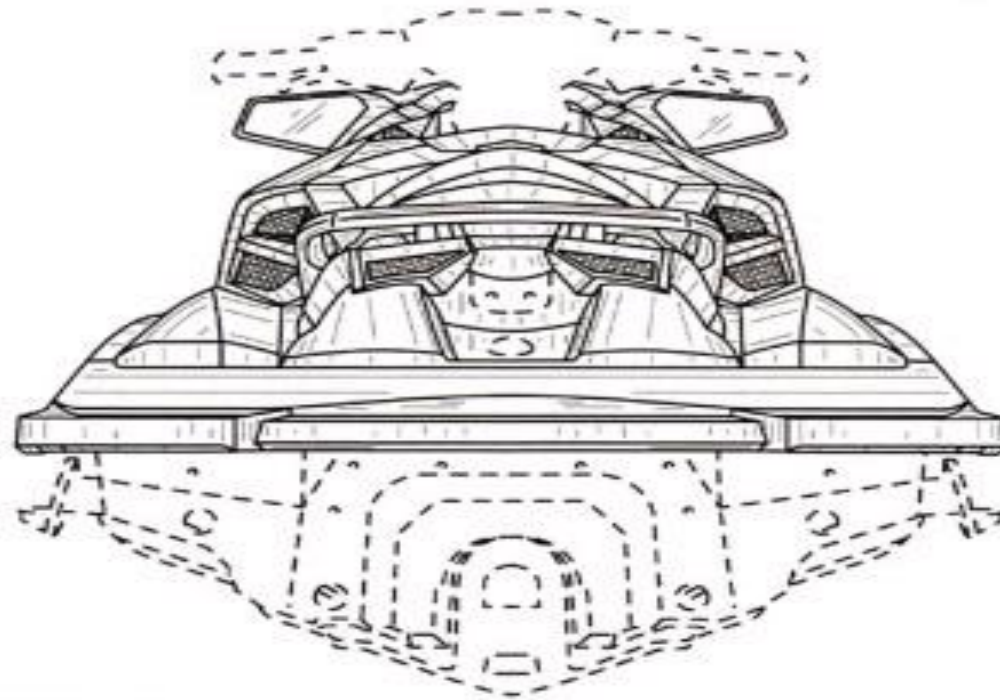

Proceso de examen



Proceso de examen



Proceso de examen



Proceso de examen

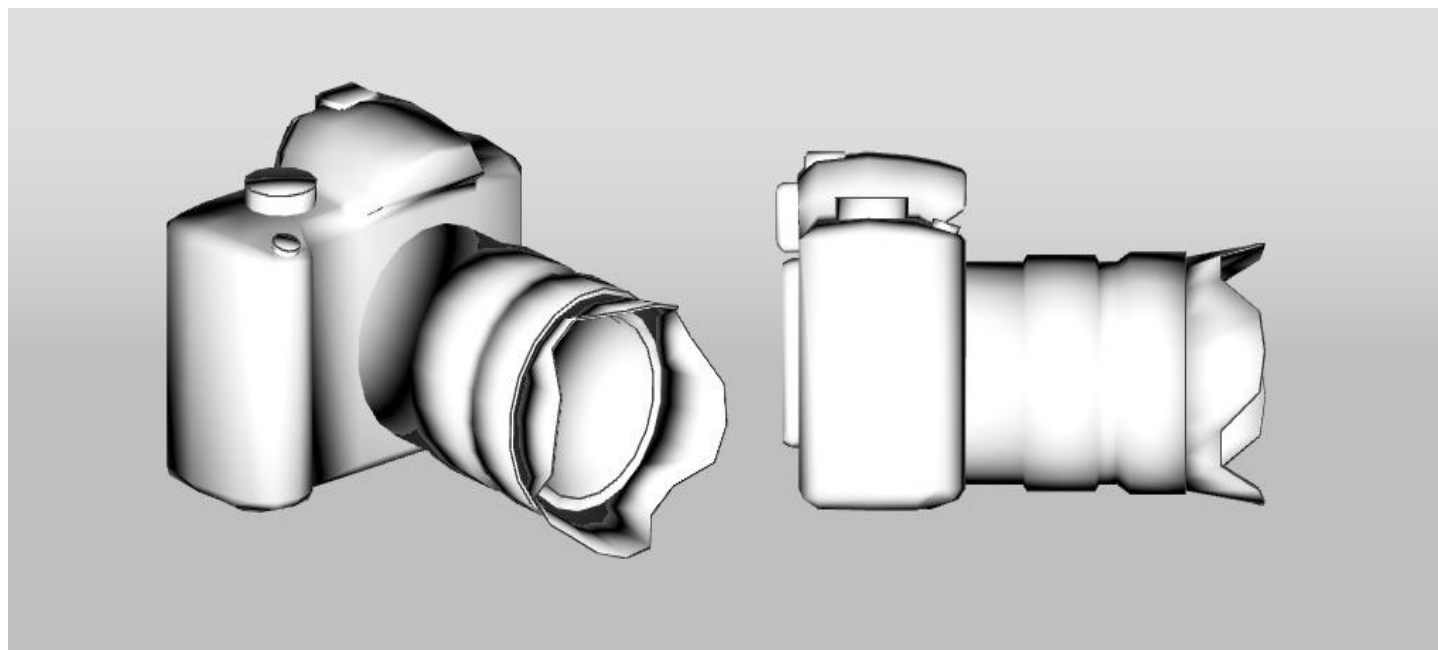

Proceso de examen

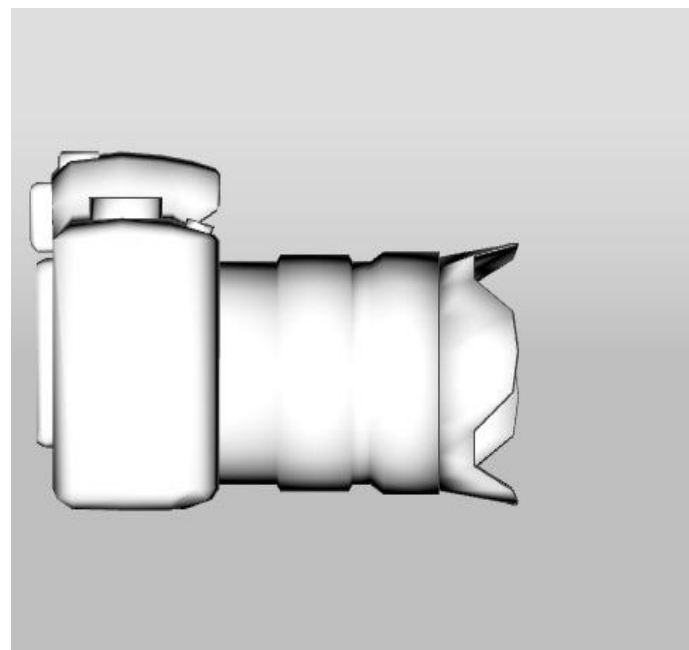
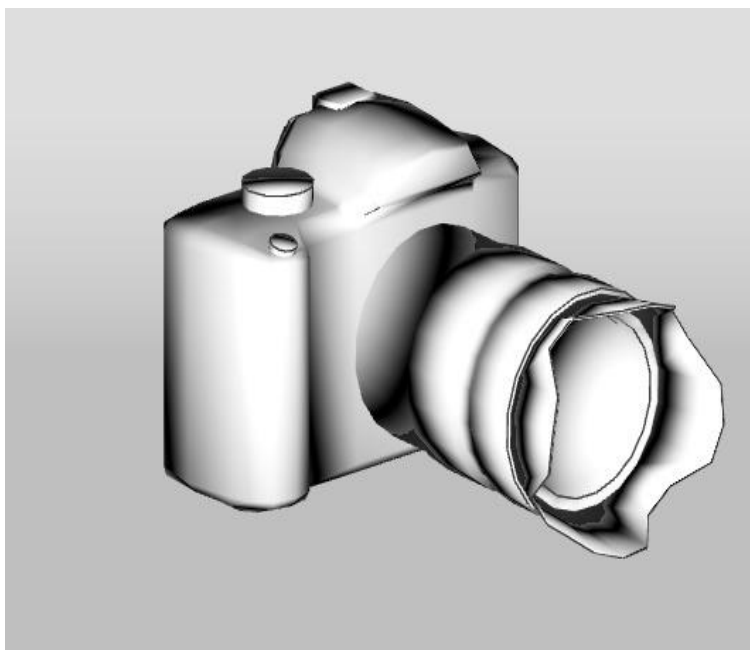

Proceso de examen



Proceso de examen



Ejemplos especiales

EJEMPLOS ESPECIALES:

- Conjuntos de artículos
- Productos complejos

Conjuntos de artículos



Productos complejos

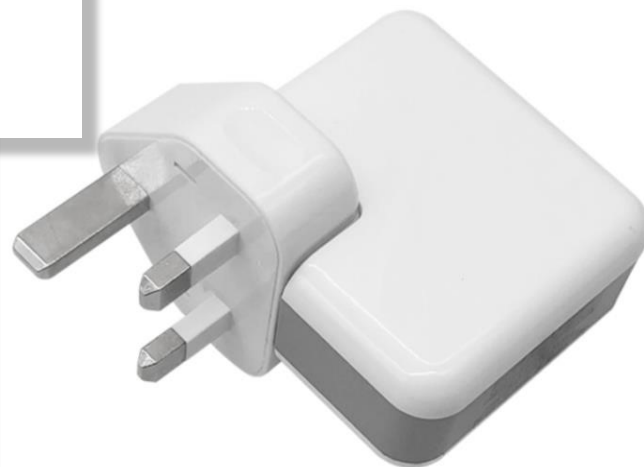

Proceso de examen



Proceso de examen

Elementos opcionales de una solicitud de diseño:

- Descripción
- Aplazamiento de la publicación
- Prioridades
- Mención del diseñador

Proceso de examen

Elementos opcionales de una solicitud de diseño:

- **Descripción**
- Aplazamiento
- Prioridades
- Mención del diseñador

Proceso de examen



INDICACIÓN DE PRODUCTO:
“Ventiladores”, Clase de Locarno 23-04

DESCRIPCIÓN:

UN CHORRO CIRCULAR DIRIGE EL AIRE CIRCUNDANTE SIN
ASPAS NI RÁFAGAS.

EL DISEÑO CUENTA CON UN IMPULSOR DE FLUJO MIXTO
QUE COMBINA LAS TECNOLOGÍAS UTILIZADAS EN
TURBOCARGADORES Y MOTORES DE AVIÓN, LO QUE
GENERA UN POTENTE FLUJO DE AIRE.

MOTOR SIN ESCOBILLAS.

Proceso de examen



DESCRIPCIÓN:

NO SE BUSCA PROTECCIÓN PARA LOS COLORES DEL DISEÑO

Proceso de examen

Elementos opcionales de una solicitud de diseño:

- Descripción
- **Aplazamiento de la publicación**
- Prioridades
- Mención del diseñador

Proceso de registro

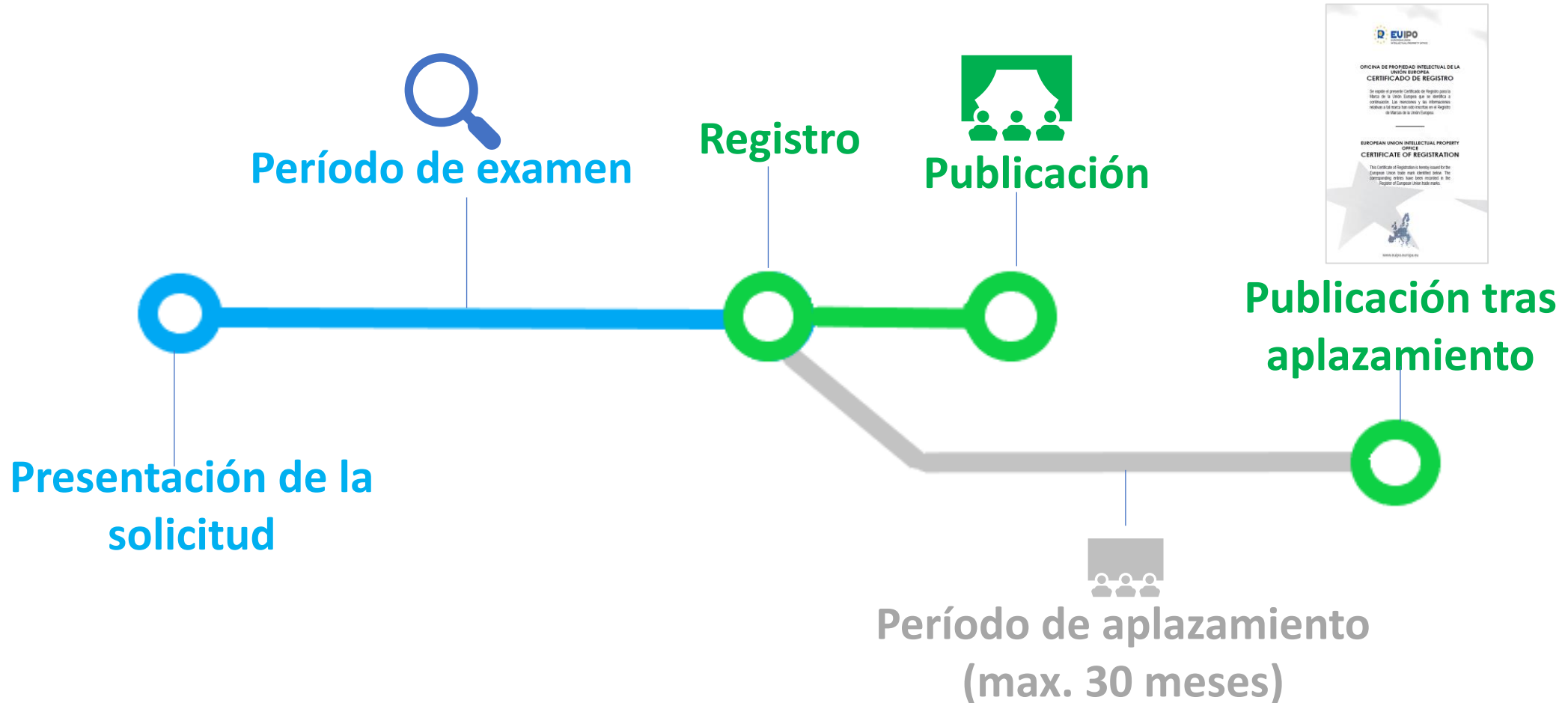

Proceso de examen

Elementos opcionales de una solicitud de diseño:

- Descripción
- Aplazamiento
- **Prioridades**
- Mención del diseñador

Proceso de examen

Reivindicación de Prioridad

- La solicitud anterior se presentó hace menos de 6 meses.
- La reivindicación de prioridad se presenta en el plazo de un mes.
- Los documentos de prioridad se presentan en un plazo de 3 meses.
- El sistema WIPO DAS permite proporcionar sólo un código.

Proceso de examen

Prioridad de exposición

- Válida para exposiciones reconocidas por el Convenio de París
- La primera divulgación del diseño tuvo lugar hace menos de 6 meses.
- La reivindicación de prioridad se presenta en el plazo de un mes.
- Los documentos de prioridad se presentan en un plazo de 3 meses.

Proceso de examen

Elementos opcionales de una solicitud de diseño:

- Descripción
- Aplazamiento
- Prioridades
- **Mención del diseñador**

AL-INVEST Verde 



DERECHOS DE PROPIEDAD INTELECTUAL

 IPKey

LATIN AMERICA

¡GRACIAS!

 Global
Gateway

Financiado por la Unión Europea

 **EUIPO**
OFICINA DE PROPIEDAD INTELECTUAL
DE LA UNIÓN EUROPEA